



JVC

ENGLISH
DEUTSCH
FRANÇAIS
ITALIANO

InteriArt

LT-26B60BU

LT-26B60SU

JVC

WIDE LCD PANEL TV

INSTRUCTIONS

BREITBILD-LCD-TV

BEDIENUNGSANLEITUNG

TÉLÉVISEUR À GRAND ÉCRAN LCD

MANUEL D'INSTRUCTIONS

TV A PIENO SCHERMO LCD

ISTRUZIONI



50074712

1004TKH-VT-VT



Contents

For your safety	1
Important Information	4
Remote Control Buttons	5
Control Panel Buttons and Terminals	6
How to remove the stand	8
Installing TV on the wall	9
Preparation	10
Before Switching on your TV	10
Switching the TV ON/OFF	11
Initial Settings	12
Operating the TV	13
Menu System	14
Other Features	20
PC Mode	23
Teletext	25
Peripheral Equipment Connections	26
Antenna Connections	28
Peripheral Equipment Connections	28
PC Input Typical Display Modes	29
Tips	30
Specifications	31

For your safety

This equipment has been designed and manufactured to meet international safety standards but, like any electrical equipment, care must be taken if you are to obtain the best results and safety is to be assured. So, please read the points below for your own safety. They are of a general nature, intended to help you with all your electronic consumer products and some points may not apply to the goods you have just purchased.

Some “DOs” and “DON'Ts” for you Air Circulation...

Leave at least 10cm clearance around the television to allow adequate ventilation. This will prevent the TV from overheating and consequential possible damage to the TV. Dusty places should also be avoided.

Heat Damage...

Damage may occur if you leave the TV in direct sunlight or near a heater. Avoid places subject to extremely high temperatures or humidity, or locations where the temperature is likely to fall below 5°C (41°F).

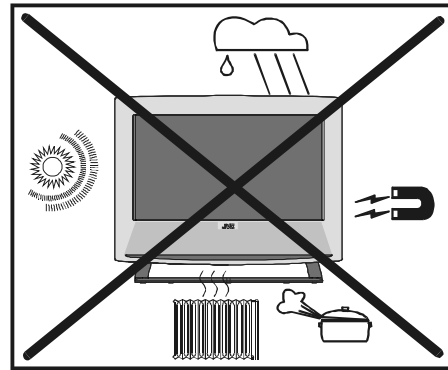

DO ensure that the TV is not standing on the mains lead. DO NOT cut off the mains plug from this equipment, this incorporates a special Radio Interference Filter, the removal of which will impair its performance.

Hot / Moderate Climate Conditions

This device is suitable for working in hot and moderate climate conditions.

**IF IN DOUBT PLEASE CONSULT A
COMPETENT ELECTRICIAN.**

DO...

DO read the operating instructions before you attempt to use the equipment.

DO ensure that all electrical connections (including the mains plug, extension leads and inter-connections between pieces of equipment) are properly made and in accordance with the manufacturers' instructions.

Switch off and withdraw the mains plug before making or changing connections.

DO consult your dealer if you are ever in doubt about the installation, operation or safety of your equipment.

DO be careful with glass panels or doors on equipment.

DO NOT...

DON'T remove any fixed cover as this may expose dangerous voltages.

DON'T obstruct the ventilation openings of the equipment with items such as newspapers, table-cloths, curtains etc. Overheating will cause damage and shorten the life of the equipment.

DON'T allow electrical equipment to be exposed to dripping or splashing or objects filled with liquids, such as vases, to be placed on the equipment.

DON'T place hot objects or naked flame sources, such as lighted candles or night-lights on, or close to the equipment. High temperatures can melt plastic and lead to fires.

DON'T use makeshift stands and NEVER fix legs with wood screws. To ensure complete safety, always fit the manufacturer's approved stand or legs with the fixings provided according to the instructions.

DON'T listen to headphones at high volume, as such use can permanently damage your hearing.

DON'T leave equipment switched on when it is unattended, unless it is specifically stated that it is designed for unattended operation or has a standby mode. Switch the equipment off and make sure your family know how to do this. Special arrangements may need to be made for infirm or handicapped people.

DON'T continue to operate the equipment if you are in any doubt about it working normally, or it is damaged in any way – switch off, withdraw the mains plug and consult your dealer.

DON'T put the empty batteries into garbage instead of recycle bin to reduce harmful effects to the environment.

ABOVE ALL – NEVER let anyone, especially children, push anything into holes, slots or any other openings in the case – this could result in a fatal electric shock.

NEVER guess or take chances with electrical equipment of any kind – it is better to be safe than sorry.

To fully disconnect the TV, switch off the mains socket and remove the Power plug.

*** Cold cathode fluorescent lamp in LCD PANEL contains a small amount of mercury, please follow local ordinances or regulations for disposal.*

“The LCD panel is very high technology product with about a million thin film transistors, giving you fine picture details. Occasionally, a few non-active pixels may appear on the screen as a fixed point of blue, green or red. Please note that this does not affect the performance of your product.”

Please note that certain light guns used with games consoles may not work on this product.

Warning:

This is a Class A product. In a domestic environment this product may cause radio interference in which case the user may be required to take adequate measures.

WARNING: TO PREVENT FIRE OR SHOCK HAZARD, DO NOT EXPOSE THIS APPLIANCE TO RAIN OR MOISTURE.

WARNING

- Do not allow children to hang from the TV, place their elbows on the TV or lean against the TV. Doing so may cause the TV to fall over and lead to injuries.

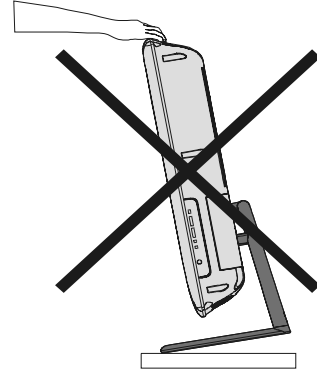

CAUTION:

- To avoid electric shock or damage to the unit, first firmly connect the small end of the power cord to the rear of the TV and then plug the larger end of power cord into an AC outlet.

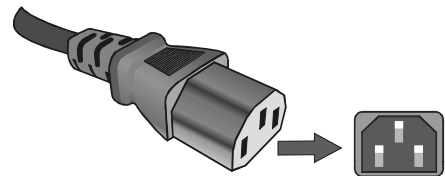

CAUTION:

- The TV screen may be damaged if the TV is carried as shown in the diagram. The TV should always be carried by two people.

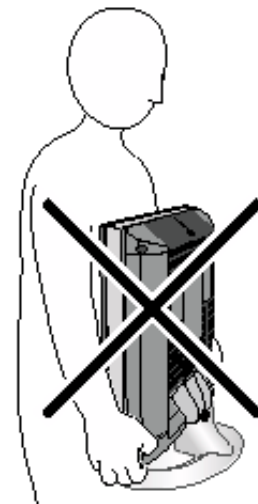

Important Information

Please take note

EXCLUSION CLAUSE

JVC shall under no circumstances be liable for loss and/or damage to the product caused by:

- fire;
- earthquake;
- accidental damage;
- intentional misuse of the product;
- use of the product in improper conditions;
- loss and/or damage caused to the product whilst in the possession of a third party;
- any damage or loss caused as a result of the owner's failure and/or neglect to follow the instructions set out in the owner's manual;
- any loss or damage caused directly as a result of misuse or malfunction of the product when used simultaneously with associated equipment;

Furthermore, under no circumstances shall JVC be liable for any consequential loss and/or damage including but not limited to the following, loss of profit, interruption of business, the loss of recorded data whether caused during normal operation or misuse of the product.

WARNING! NEVER LEAVE A STATIONARY IMAGE ON THE SCREEN

If stationary images generated by TELETEXT, CHANNEL IDENTIFICATION LOGOS, COMPUTER DISPLAYS, VIDEO GAMES, ON SCREEN MENUS, etc. are left on the TV screen for any length of time, they could become permanently ingrained.

If you use your television to display completely still images, or moving pictures which have a permanent still image superimposed e.g. broadcast network logos, it is always advisable to reduce BOTH the brightness and contrast settings.

Care and disposal

Cleaning the screen and cabinet...

Turn off the power, clean the screen and cabinet with a soft, dry cloth. We recommend that you do not use any proprietary polishes or solvents on the screen or cabinet as this may cause damage.

Disposal...

When the set reaches the end of its useful life please dispose of it in accordance with Local Government Regulations or at a recycling centre.

Remote Control Buttons

- ① = (Stand By) button
- ② TV / VCR / DVD Switch
- ③ Number buttons
- ④ **AV** button
(EXT-1, EXT-2, EXT-2S, EXT-3,
EXT-4, EXT-4S, PC)
- ⑤ **BLUE / PICTURE** Mode button
- ⑥ **YELLOW** / Sleep Timer button
- ⑦ **MENU** button
- ⑧ = Cursor Up button
- ⑨ **OK** button
- ⑩ = Cursor Right button
- ⑪ **BACK** button
- ⑫ = Volume + / - buttons
- ⑬ Teletext / VCR / DVD Control buttons
- ⑭ PC Control Buttons
- ⑮ P buttons
- ⑯ = Cursor Down button
- ⑰ = Teletext Button
- ⑱ = Cursor Left button
- ⑲ I/II = Stereo / Bilingual button
- ⑳ **GREEN** / Hyper Sound On/Off button
- ㉑ **RED** / ZOOM Mode button
- ㉒ = Information Button / T-V Link in Programme Menu
- ㉓ = Mute button

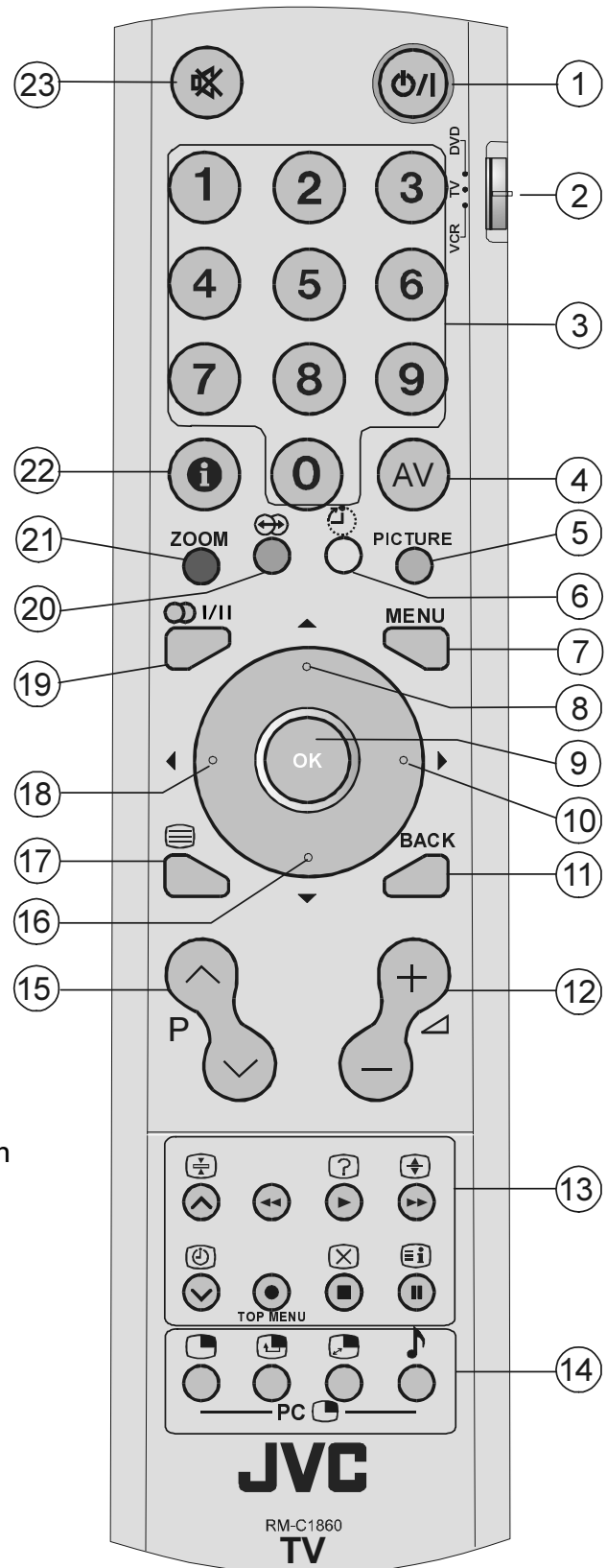

Control Panel Buttons and Terminals

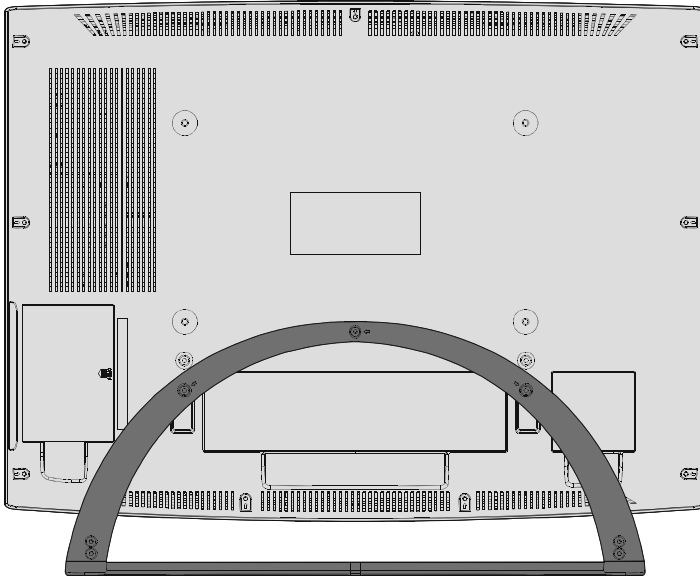
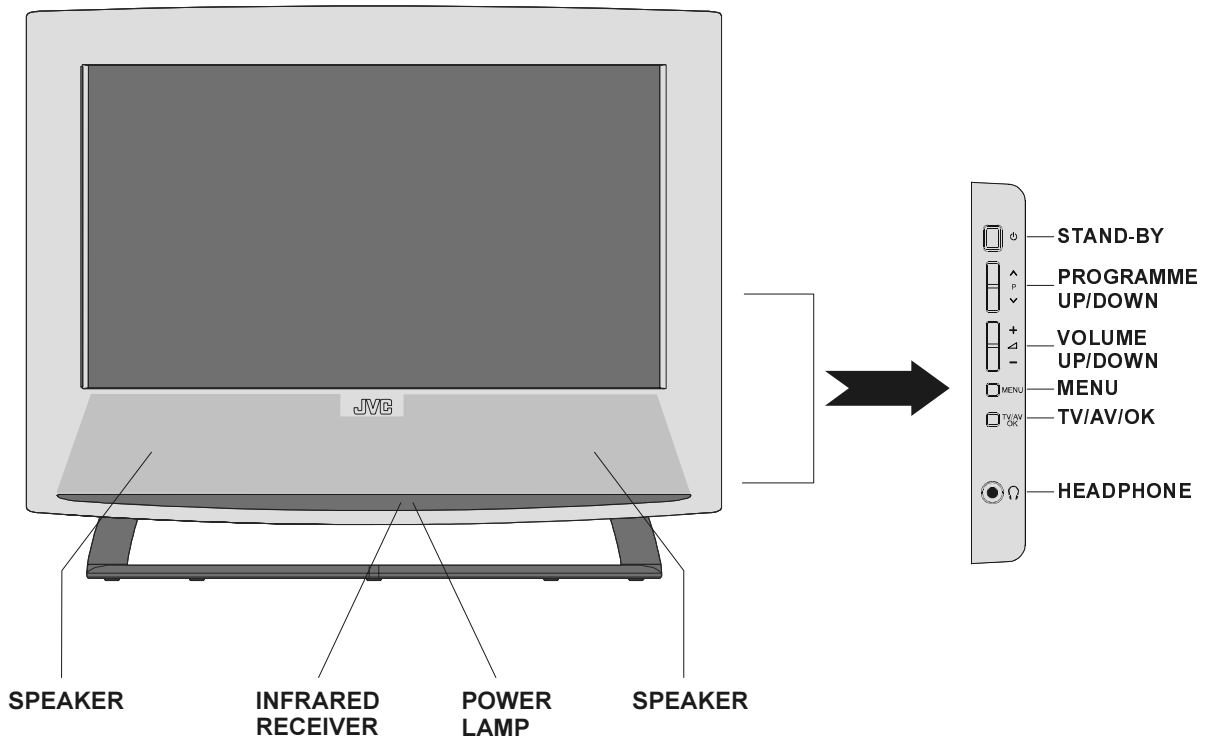

With certain combinations of connectors and leads the back cover may not be easily fitted. If the cover is left off, this in no way infringes safety requirements.

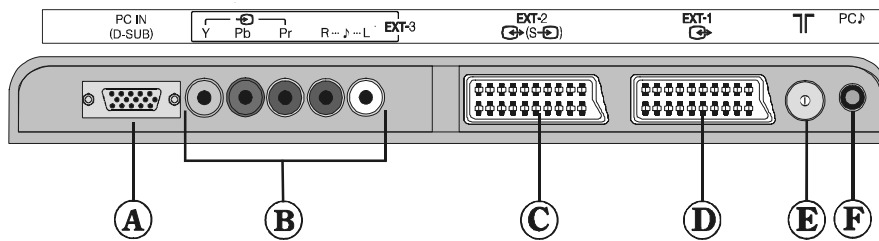
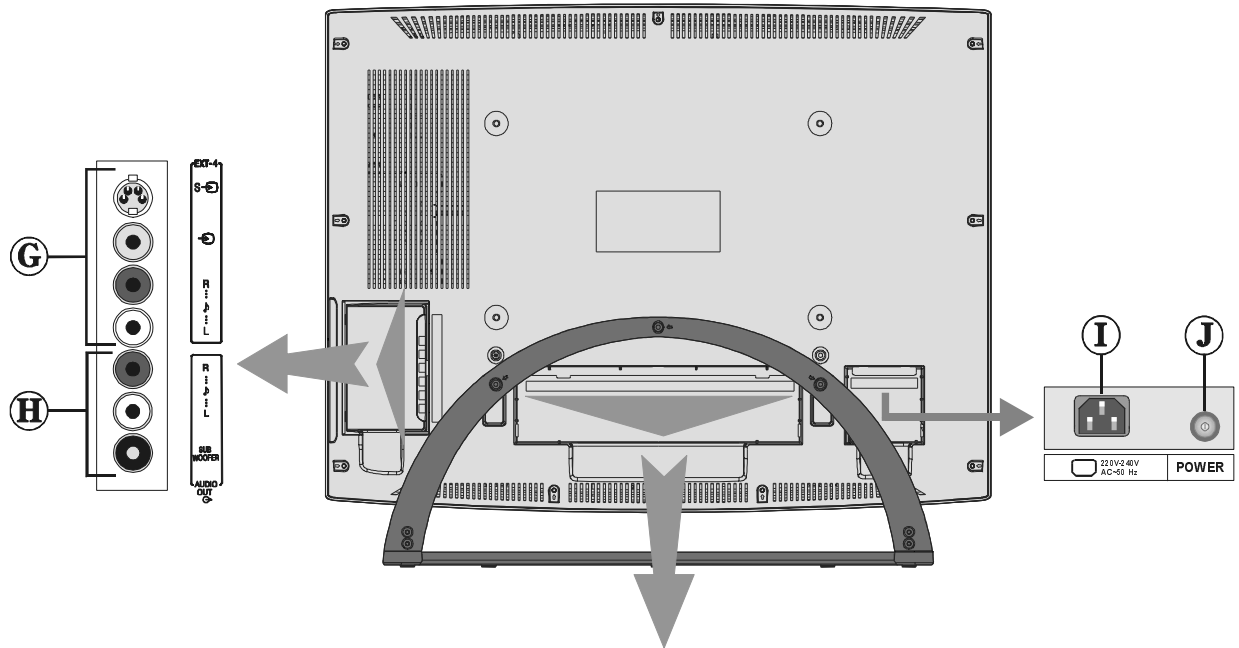

- Ⓐ PC INPUT
 - Ⓑ EXT-3 ————
 - Ⓒ EXT-2
 - Ⓓ EXT-1
 - Ⓔ ANTENNA
 - Ⓕ PC AUDIO IN
 - Ⓖ EXT-4 ————
 - Ⓗ AUDIO OUT
TERMINAL ————
 - Ⓘ POWER CORD INPUT
 - Ⓝ ON/OFF SWITCH
- Y
Pb
Pr
Component Audio In R
Component Audio In L

S-Video In
Video In
Audio R
Audio L

Audio R
Audio L
Subwoofer Out

How to remove the stand

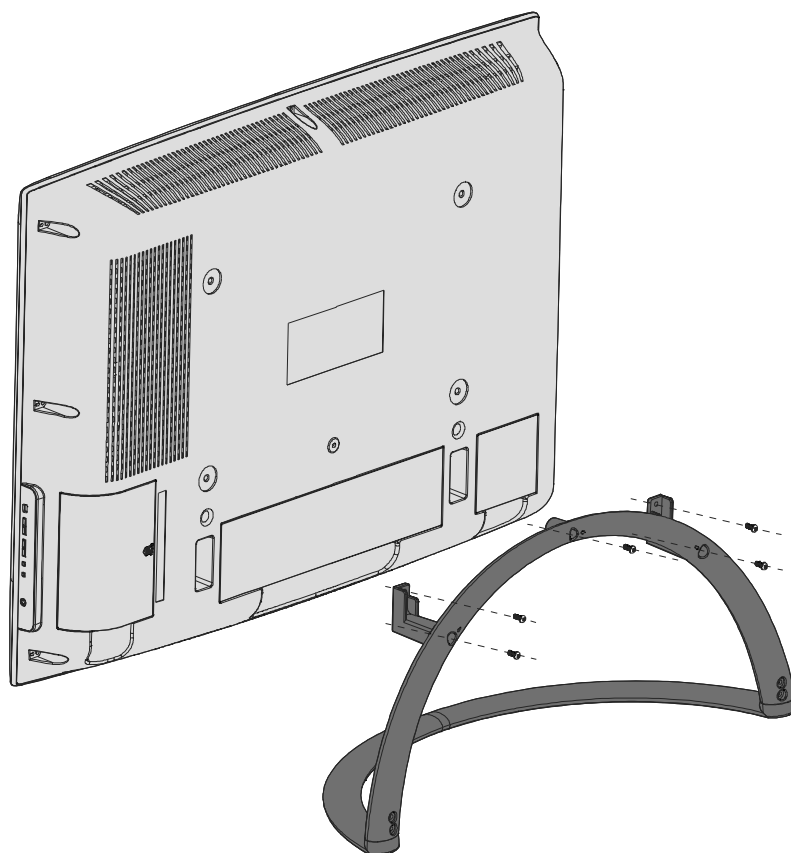

- Loosen the 5 screws that attach the stand to the TV.
- Gently pull the stand downwards to remove it.

Installing TV on the wall

WARNING

- When you install the TV on the wall, only use a JVC wall mounting unit (optional) which is designed for this TV.
- Make sure that the TV is installed on the wall by a skilled installer.

Locate the TV away from direct sunlight and strong lights, soft, indirect lighting is recommended for comfortable viewing. Place on a sturdy platform, the mounting surface should be flat and steady, it should then be secured to the wall with a sturdy tie using the hook on the back of the TV, this will prevent it from falling over. Use curtains or blinds to prevent direct sunlight falling on the screen.

A floor and table top stand are available for this television, or an angled bracket which enables the TV to be wall-mounted.

The LCD display panels are manufactured using an extremely high level of precision technology, however sometimes some parts of the screen may be missing picture elements or have luminous spots. This is not a sign of a malfunction.

Make sure the TV is located in a position where it cannot be pushed or hit by objects, as pressure will break or damage the screen.

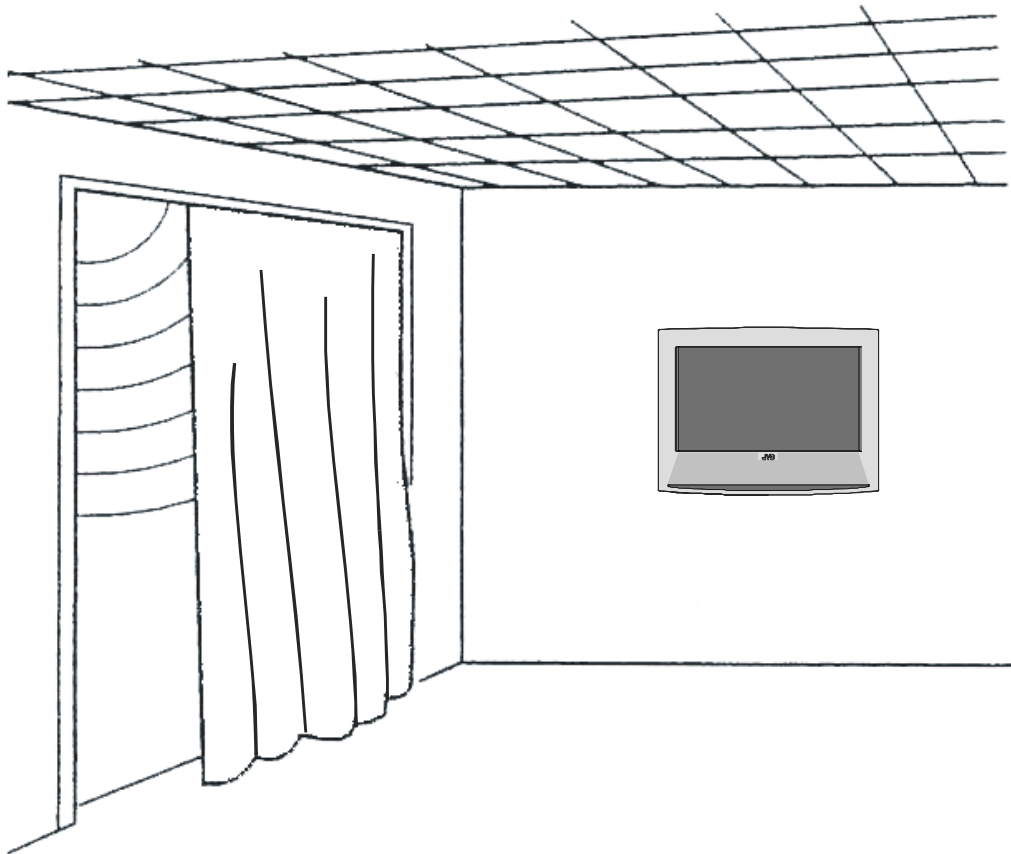

Preparation

Install Display on solid horizontal surface such as a table or desk.

For ventilation, leave a space of at least 10 cm free all around the set. To prevent any fault and unsafe situations, please do not place any objects on top of the set.

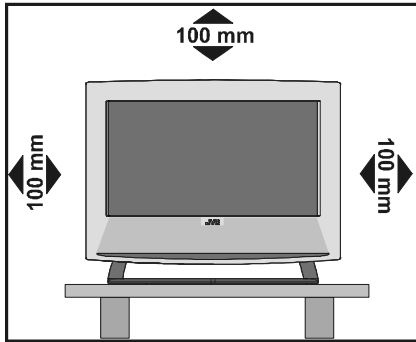

Features

- It is a remote controlled colour television and PC monitor.
- 100 programmes from VHF, UHF bands or cable channels can be preset.
- It can tune cable channels.
- Controlling the TV is very easy by its menu driven system.
- It has 2 pieces of Euroconnector sockets for external devices (such as video, video games, audio set, etc.)
- German+Nicam stereo sound system.
- Multilanguage OSD.
- Teletext (Fastext, 7 pages).
- It is possible to connect headphone.
- A.P.S. (Automatic programming system)
- All programmes can be named.
- Forward or backward automatic tuning.
- Sleep timer.
- Child lock.
- Auto, Full, Regular, Panoramic, 14:9 Zoom, 16:9 Zoom, 16:9 Zoom Subtitle modes.
- Automatic sound mute when no transmission.

- When no valid signal is detected, after 5 minutes the TV switches itself automatically to stand-by mode.
- NTSC Playback.
- PLL (Channel Search)
- TV Picture in PC (if PC input available).
- PC input (Support Up to 1366 x 768)
- Audio Lineout

Before Switching on your TV

Power connection

IMPORTANT: The TV set is designed to operate on 220-240V AC, 50 Hz.

- After unpacking, allow the TV set to reach the ambient room temperature before you connect the set to the mains.

Connections to the RF input socket

- Connect the aerial or cable TV plug to the RF input socket located at the back of the TV and connect the cable plug coming out from the TV out socket located at the devices (VCR, DVB etc.) to this socket as well.

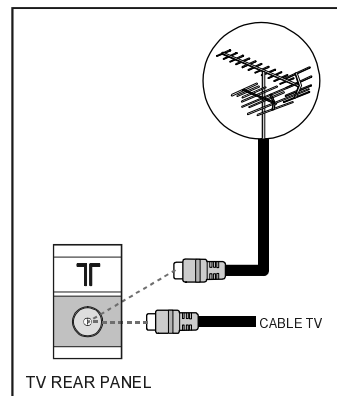

How to connect other devices

IMPORTANT: Switch off the TV before connecting any external device.

Sockets for external connections are at the back of the TV. For connection of other devices via Euroconnector refer to the manuals of the related devices.

Inserting batteries in the remote control handset

- Remove the battery cover located on the back of the handset by gently pulling downwards from the indicated part.
- Insert two AAR6 dry cell or equivalent type of batteries inside.
- Replace the battery cover.

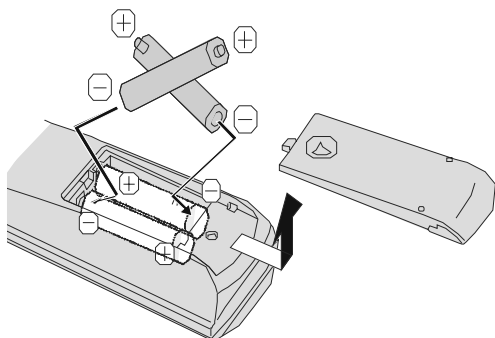

NOTE: Remove the batteries from remote control handset when it is not to be used for a long period. Otherwise it can be damaged due to any leakage of battery.

Old batteries must be disposed in a designated area. If performance of the remote control reduces, replace the batteries with the correct type. Do not combine a used, old battery or a new one or mixed battery types. Remove dead batteries immediately to prevent acid from leaking into the battery compartment.

Switching the TV ON/OFF

To switch the TV on

Your TV will switch on in two steps:



- 1- Connect the power cord to the system. Press the On/Off switch at the rear of the TV. Then the TV switches itself to stand-by mode and the power lamp becomes red located on the front of the TV.
- 2- To switch on the TV from stand-by mode either:

Press the “ / I” button on the remote control or on the right side of the TV

or,

Press a digit button on the remote control so that a programme number is selected,

or,

Press “**P**” or “**P**” buttons on the remote control or on the right side of the TV, so that last switched off programme is selected.

Either way the TV will switch on and the power lamp will become green.

To switch the TV off

- Press the “ / I” button on the remote control or on the right side of the TV, so the TV will switch to stand-by mode and the power lamp will become red.

NOTE: To switch the TV off completely, press the On/Off switch at the rear of the TV or remove the mains plug from the socket.

Initial Settings

First A.P.S. (Automatic Programming System)

When you turn the TV on for the first time, the first APS menu appears.

APS, searches and sorts all channels and stores them automatically on your TV, according to the transmission of programme systems in your area.

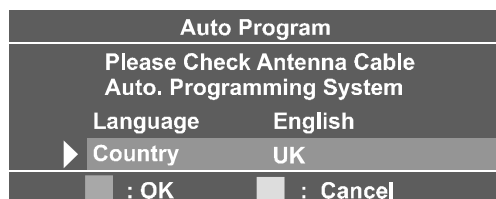

To cancel APS before starting, press BLUE button.

First of all choose the "Language" which the menus of the TV will appear. As soon as you change the language, the menu items will be displayed in the selected language. By pressing the "▲" or "▼" button, come to the "Country" item and select the country. This will affect the sort process in APS. Press Red button to start A.P.S.

After APS is finalized, a programme list will appear on the screen. In the programme list you will see the programme numbers and names assigned to the programmes.

If you press the BLUE button at any time while the A.P.S. is running, the A.P.S. will be ended.

If you do not accept the locations and / or the programme names of programmes, you can change them in Program menu. For details see **Program Menu** on page 18.

If you do not have a T-V Link compatible VCR, press MENU button to exit the menu.

If you have a T-V Link compatible VCR connected to the EXT-2 terminal, press "i" button to display T-V Link menu. Then follow the operating procedure "Downloading data to VCR" in the following T-V Link section.

T-V Link

When a T-V Link compatible VCR connected to the EXT-2 terminal on the TV, it is easier to set up the VCR and to view videos. T-V Link uses the following features:

To use T-V Link functions

A "T-V Link compatible VCR" means a JVC video cassette recorder with the T-V Link logo, or with one of the following logos. For details see your VCR instruction manual.

"Q-LINK" (A trademark of Panasonic Corporation)

"Data Logic" (A trademark of Metz Corporation)

"Easy Link" (A trademark of Philips Corporation)

"Megalogic" (A trademark of Grundig Corporation)

"SMARTLINK" (A trademark of Sony Corporation)

Downloading data to VCR:

The VCR will automatically download the registered data on the TV channels from the TV. This means you do not need to set up the programme channels on your VCR manually. The "T-V Link" menu will be displayed when you press the "i" button while **Program** menu is displayed.

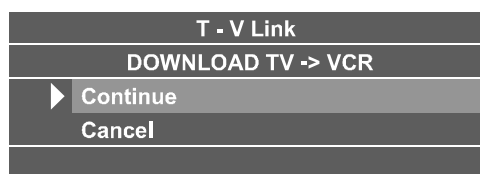

If you do not have a T-V LINK compatible VCR, select Cancel and press "▶" or "OK" button to exit the menu.

Press "▶" or "OK" button to start downloading data to VCR. "TRANSFER" is displayed in the menu.

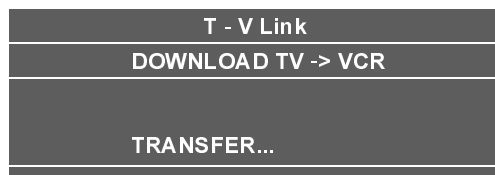

If “**FEATURE NOT AVAILABLE**” is displayed, download was not performed correctly. Before trying to download again, check that:

- The VCR power is turned on.
- The VCR is T-V Link compatible.
- The VCR is connected to the EXT-2.
- The scart cable is fully wired.

Direct REC:

You can easily record to VCR the images that you are watching on the TV. For details, read the manual for your VCR. Use your VCR controls. You can not carry out Direct REC using your TV control.

When the VCR is not ready (For example when there is no tape inserted), “**NO RECORDING**” is displayed. In the following situations, the VCR will stop recording if the TV is turned off, if the TV channel or input is changed, or if the menu is displayed on the TV:

- When recording images from an external device connected to TV (For example camcorder).
- When recording a TV channel after it has been unscrambled on a decoder.
- When recording a TV channel by using the TV's output because the VCR's own tuner can not properly receive that channel.

TV autopower on/VCR image view:

When the VCR starts playing, the TV automatically turns on and images from EXT-2 appear on the screen.

This function does not happen if your TV's main power is turned off. Set your TV's main power to on (StandBy Mode).



Operating the TV

You can operate your TV using both the remote control handset and onset buttons.



Volume setting and programme selection can be made by using the buttons at the control panel on the right side of the TV.

Operating with the buttons on the TV

Volume Setting

- Press “ -” button to decrease volume or “ +” button to increase volume, so a volume level scale (slider) will be displayed at the middle of the bottom on the screen.





Programme Selection

- Press “**P**” button to select the next programme or “**P**” button to select the previous programme.

Switching input mode

- Pressing TV/AV/OK button will change the input mode.

Entering Main Menu



- Press “**MENU**” button to enter Main menu. In the Main menu select submenu using “**P**” or “**P**” button and enter the submenu using “ -” / “ +” or TV/AV/OK button. To learn the usage of the menus, refer to the Menu System sections.

Operating with Remote Control

The remote control handset of your TV is designed to control all the functions of the model you selected. The functions will be described in accordance with the menu system of your TV.

Functions of the menu system are described in following sections.

Volume Setting

Press “ +” button to increase volume. Press “ -” button to decrease volume. A volume level scale (slider) will be displayed in the middle at the bottom of the screen.

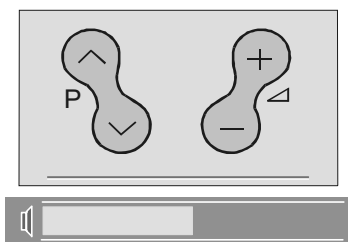

Programme Selection (Previous or next programme)

- Press “P▽” button to select the previous programme.
- Press “P△” button to select the next programme.

Programme Selection (direct access):

Press digit buttons on the remote control handset to select programmes between 0 and 9. TV will switch to the selected programme. To select programmes between 10 - 99, press the digit buttons consecutively which programme you want to select (eg. for programme 27, first press 2 and then 7). When it is late to press second digit button only the first digit programme will be displayed. The limit of the delay time is 3 seconds.

Example: PR6 → press 6,

PR12 → press 1 and 2

Press directly the programme number to reselect single digit programmes.

Hint: The channel list numbers are assigned by the broadcasters. Because not all channels are broadcast free-to-air and stored by the receiver, the channel list numbers do not run continuously. The fifteenth channel in the list, for example, may not be channel number 15 but channel number 17.

Menu System

Your TV has been designed with a menu system to provide an easy manipulation of a multi-function system. The TV is controlled by choosing the commands, which are displayed on the screen.

MAIN MENU

Press the “MENU” button. The main menu will be displayed in the middle of the screen.



To select a sub-menu use “▲” or “▼” button, and press “◀” or “▶” button or directly press “OK” button.

In EXT-1, EXT-2, EXT-3 and EXT-4 modes, main menu appears the same as in TV mode but without Program sub-menu.

Menu does not disappear automatically if it is left on the screen.

- Press the “MENU” button again to remove menu.
- Press the “BACK” button to return to the previous menu.

Picture Menu

Press “MENU” button, now you are in main menu. In the Main menu, select “Picture” using “▲” or “▼” button, then enter the Picture menu by pressing “◀” / “▶” or “OK” button.

Setting Mode

- As you enter the picture menu, **Mode** will be the first item.
- By pressing “◀” or “▶” button you may choose one of these options:
Soft, Standard and Bright.

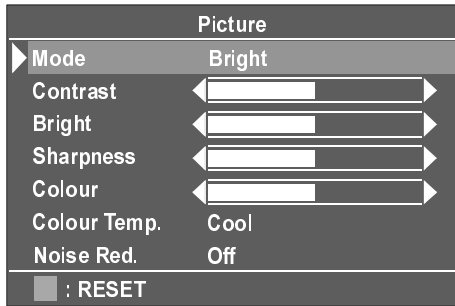

Setting Contrast

- Using “▲” or “▼” button select **Contrast**.
- Press “▶” button to increase contrast level.
- Press “◀” button to decrease contrast level.

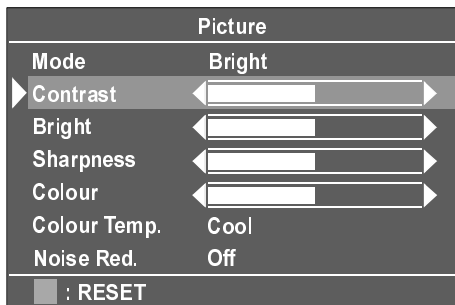

Setting Bright

- Using “▲” or “▼” button select **Bright**.
- Press “▶” button to increase brightness.
- Press “◀” button to decrease brightness.

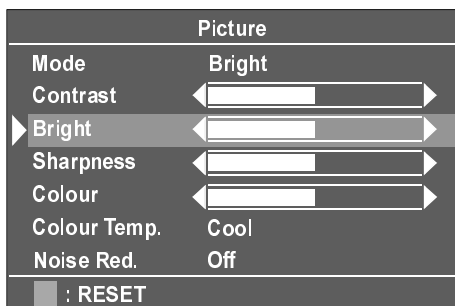

Setting Sharpness

- Using “▲” or “▼” button select **Sharpness**.
- Press “▶” button to increase sharpness level.
- Press “◀” button to decrease sharpness level.

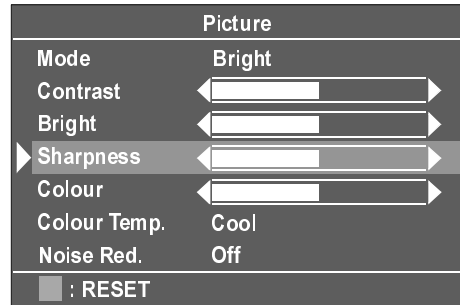

Setting Colour

- Using “▲” or “▼” button select **Colour**.
- Press “▶” button to increase colour level.
- Press “◀” button to decrease colour level.

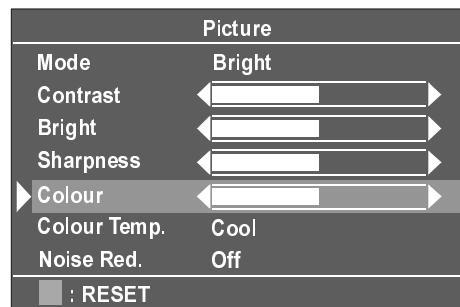

Setting Colour Temp.

- Using “▲” or “▼” button select **Colour Temp.**
- Press “◀” or “▶” button to select “**Warm**”, “**Cool**” or “**Normal**”.

Setting Noise Reduction

- Using “▲” or “▼” button select **Noise Red.**
- Press “◀” or “▶” button to select Noise Reduction level “**Off**” or “**Minimum**” or “**Medium**” or “**Maximum**”.

Note 1:

At low signal level, the changings on the Noise Reduction function are not effective when there is menu on the screen. If the menu is removed, the effect of this function is seen. At normal broadcasting, Noise Reduction changings are effective at once.

Note 2:

At moving pictures, while Noise Reduction is at maximum level, some picture distortions may occur. If Noise Reduction is set to medium or minimum, the picture will improve.

Setting Hue

During Playback NTSC system, this will appear in AV mode only when NTSC video source is applied. Otherwise, Hue option is invisible in Picture menu in TV mode :

- Using “▲” or “▼” button select **Hue**.
- Press “▶” button to increase hue level.
- Press “◀” button to decrease hue level.

Reset

Press BLUE button to reset the picture modes to factory default settings.

To Store the Settings

In the **Picture** Menu, all settings are stored automatically.

Sound Menu

As you enter the main menu, sound will be the second item. In the main menu, select **Sound** using “▲” or “▼” button, then enter the sound menu by pressing “◀” / “▶” or “OK” button.

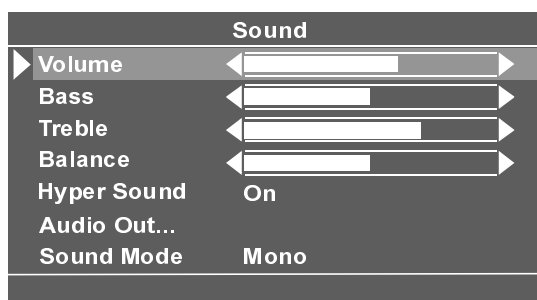

Setting Volume

As you enter the sound menu, **Volume** will be the first selected option.

- Press “▶” button to increase volume.
- Press “◀” button to decrease volume.

Or you can directly change the volume settings using “▲ +” (to increase) or “- ▼” (to decrease) button.

Setting Bass Level

- Using “▲” or “▼” button select **Bass** Level.
- Press “▶” button to increase bass level.
- Press “◀” button to decrease bass level.

Setting Treble Level

- Using “▲” or “▼” button select **Treble**.
- Press “▶” button to increase treble level.
- Press “◀” button to decrease treble level.

Setting Balance

It allows adjusting the distribution between the left and right speakers.

- Using “▲” or “▼” button select **Balance**.
- Press “▶” button to change balance rightward.
- Press “◀” button to change balance leftward.

Hyper Sound

- Using “▲” or “▼” button select **Hyper Sound**.
- Pressing “◀” or “▶” button will turn this feature on or off.

Pseudo/spatial effect can be turned on or off via the Hyper Sound item in the Sound menu or by remote control. In Mono transmission the left and right channels will be added at left channel and dummy stereo effect will be introduced to end-user.

In stereo transmission it yields a phase difference between left and right channels. Hyper Sound selection will be displayed on the screen when the TV Status button is pressed or programme is changed.

To Change Audio Out Settings

Audio Out is a sub-menu of Sound menu.

Use this settings to adjust volume for audio out terminal which is located at the right side of the TV.

- Using “▲” or “▼” button select Audio Out.
- Press “◀” or “▶” button or directly press “OK” button on **Audio Out**, to enter the Audio Out menu.



Audio Out Volume

- As you enter the Audio Out sound menu, Volume will be the only option.

- Press “▶” button to increase volume.
- Press “◀” button to decrease volume.

Selecting Sound Mode

- Using “▲” or “▼” button select Sound Mode.
- Press “◀” or “▶” button to change Sound Mode.

You can choose **Mono**, **Stereo** or **Dual (I-II)** mode, only if the selected channel supports that Sound Mode.

You can also change sound mode directly pressing “I-II” button on your remote control.

To Store The Settings

In the **Sound** Menu, all settings are stored automatically.

Feature Menu

Press “**MENU**” button, now you are in main menu. In the main menu, select **Feature** using “▲” or “▼” button. Then enter the Feature menu by pressing “◀” / “▶” or “**OK**” button.

Feature	
▶ Sleep Timer	Off
Child Lock	Off
Language	English
EXT-2 Output	TV
Blue Back	Off

Sleep Timer

The **Sleep Timer** is used to turn the TV off after a defined period of time after selecting this item. The timer can be programmed between Off and 120 minutes in steps of 10 minutes. (Off, 010, 020, 030, 040, ... , 120)

If sleep timer is activated, at the end of the selected time, the TV goes automatically to stand-by mode.

Child Lock

You can use this feature to prevent children turning the TV on/off or changing programmes or adjustments etc. without remote control.

- Using “▲” or “▼” button select **Child Lock**.
- Press “◀” / “▶” button to select Child Lock On or Off.

When **Off** is selected, there will be no difference in the operation of your TV. When **On** is selected, the TV can only be controlled by the remote control handset. In this case the control panel buttons except “⏻” button on the right side of the TV will not work.

Selecting Menu Language

- Using “▲” or “▼” button select **Language**.
- Press “◀” or “▶” button to select menu language.

EXT-2 Output

From EXT-2 Output; **TV**, **EXT-1** or **EXT-4** can be given. These modes can be chosen by pressing “◀” or “▶” button on “**EXT-2 Output**”.

Feature	
Sleep Timer	Off
Child Lock	Off
Language	English
▶ EXT-2 Output	TV
Blue Back	Off

Blue Back (During No Signal)

The **Blue Back** Feature can be set by “◀” or “▶” button to either **On** or **Off**.

To Store Settings

In **Feature** menu all settings are stored automatically.

Install Menu

Press “**MENU**” button, now you are in main menu. In the main menu, select “**Install**” using “▲” or “▼” button. Then enter the Install menu by pressing “◀” / “▶” or “**OK**” button.

Install	
▶ Programme	P 02
Band	C
Channel	02
Colour System	Auto
Sound System	BG
Fine Tuning	◀-----+-----▶
Search	048.25
Decoder(EXT-2)	Off
VCR	Off
Store	

In EXT mode, Install menu appears like this:

Install	
▶ Colour System	Auto
VCR	Off

You can change only Colour system and VCR.

Selecting Programme

- Using “▲” or “▼” button select **Programme**.
- To select programme number, you can use “◀” / “▶” button or Digit Buttons.

Selecting Band

Band, can be chosen either,

- “C” or “S” by “◀” or “▶” button.

Selecting Channel

Channel can be changed by “◀” or “▶” button or by Digit Buttons.

Selecting Colour System

Using “◀” or “▶” button on **Colour System**, you can change the colour system to **PAL**, **SECAM** or **Auto**.

Note: In EXT mode, you can choose NTSC 3.58 and NTSC 4.43 as well.

Selecting Sound System

Using “◀” or “▶” button on **Sound System**, you can change the standard to **BG**, **DK**, **I**, **L**, **Lp**.

Selecting Fine Tuning

You can use the Fine Tuning process for fine adjustment (after coarse adjustment), if you are not happy about the image on the screen.

Use “◀” or “▶” button on **Fine Tuning** item, until getting the best image on the screen.

Selecting Search

To start the search process, press “▶” button for forward search or “◀” button for backward search. If a signal is found or reaches to end of the band after searching, press “◀” or “▶” buttons to continue search process. To stop the search process when you want, press “◀” or “▶” buttons at any time.

Decoder(EXT-2)

You can use this mode to connect any decoder to your TV.

- Press the “◀” or “▶” buttons to set it “**On**” or “**Off**”.

When you select **Decoder(EXT-2)** “**On**”, EXT-2 output will be chosen as TV mode only and any scrambled channels will be unscrambled through decoder connected your TV via EXT-2 output.

Setting VCR (Video Cassette Recorder) Mode

- This item can be seen in **TV**, **EXT-1**, **EXT-2**, **EXT-3** and **EXT-4** modes.
- If you want to watch a **VCR** source from one of these modes, then it will be better to set **VCR** mode “on”. For this, while the cursor is on this item press the “◀” or “▶” buttons to set it “**On**”.
- If you want to watch a **DVD**, then you must set this item “off”; because **DVD** is not a source like a **VCR** and to see the picture better, you must set the **VCR** mode “**Off**”.

To Store Settings

- Press “◀” / “▶” or “**OK**” button on **Store** option to store Install menu settings.
- After stored, T-V Link menu will appear. If you do not need to do T-V Link, select Cancel and press “▶” or “**OK**” button to exit the menu.

Program Menu

Press “**MENU**” button, now you are in main menu. In the main menu, select “**Program**” using “▲” or “▼” button. Then enter the Programme menu by pressing “◀” / “▶” or “**OK**” button.

Note: There is no Program menu in any EXT modes.

Program		P01
▶ 01	BBC	11
02	RTL	12
03	XXXXX	13
04	-----	14
05	-----	15
06	-----	16
07	-----	17
08	-----	18
09	-----	19
10	-----	20
Name		Insert
Delete		Autostore
i : T-V Link		

Program Menu is used to delete a channel, to change the programme number of a channel, to give a channel name to a channel, and to start the A.P.S (Autostore) function.

To choose a channel in the Program menu

Press ▲ / ▼ / ◀ / ▶ buttons.

Caution:

Using "Delete" or "Insert" function rewrite the current channel list in the Program menu. Therefore, the programme numbers of some of channels will change.

When you complete the settings of Program menu:

If you have a T-V Link compatible VCR, press "i" button to display the T-V Link menu. Then follow the operating procedure "Downloading the data to VCR"

T - V Link	
DOWNLOAD TV -> VCR	
▶ Continue	
Cancel	

If you do not have a T-V Link compatible VCR, select Cancel and press "▶" or "OK" button to exit the menu.

To give a channel name (Name):

1. Choose the channel you want to give a channel name.
2. Press the RED button to enter the Name mode.
3. Press "◀" or "▶" button to choose the position and press "▲" or "▼" button to choose

each character of channel name.

4. Press the RED button to store the channel name.

- To cancel the Name mode, press the BLUE button.

To delete a channel (Delete):

1. Choose the channel you want to delete.
2. Press the YELLOW button to enter the Delete mode.

3. Press the YELLOW button to delete it.

- To cancel the Delete mode, press the BLUE button.

To change the programme number of a channel (Insert)

1. Choose the channel you want to change the programme number.

2. Press the GREEN button to enter the Insert mode.

3. Press ▲ / ▼ / ◀ / ▶ buttons to choose new programme number.

4. Press the GREEN button to insert the channel to the chosen programme number.

Autostore:

To enter Autostore menu, press the BLUE button. To learn the features of this function see "Autostore" below.

Autostore, searches and stores all channels automatically on your TV, according to the transmission of programme systems in your area.

Warning	
All Prestored Programmes Will Be Deleted	
▶ Country	UK
OK	Cancel

First of all choose the "Country" by using "◀" or "▶" button.

After Autostore is finalized, a programme list will appear on the screen. In the program list you will see the programme numbers and names assigned to the programmes.

If you do not accept the locations and/or the programme names of programmes, you can change them in **Programme** menu.

Source Menu

You can switch your TV to EXT modes by pressing directly to “AV” button or by selecting in source menu from the main menu.

While in EXT mode, you can also switch your TV to TV or other EXT modes by selecting in source menu from the main menu.

In main menu, firstly use “▲” or “▼” button then use “◀” / “▶” or “OK” button to enter Source menu. In source menu, move the cursor by “▲” or “▼” button and then press “OK” button or “◀” / “▶” buttons when the cursor is on the required item. The selected mode comes automatically on the screen.

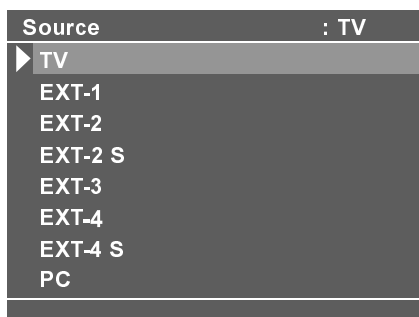

Other Features

TV Status

Programme Number, Programme Name (or EXT), (they are displayed on the upper left of the screen). The **sound indicator** is displayed with them too. They are displayed after programme change for 3 seconds.

Sound Indicator

The alternatives of the indicator are Mono, Stereo, Dual I and Dual II. This indicator is displayed under the programme number indicator on the screen. “I-II” button is used to select Mono or Stereo, or Dual I or Dual II.

Mono

In Mono broadcast or in forced-mono (for stereo broadcast).

Stereo

In Stereo broadcast.

Dual I

If dual broadcast detected. Dual I is selected in default and also can be selected after Dual II by Remote Control.

Dual II

If Dual II is selected by Remote Control.

Hyper Sound

By selecting Hyper Sound in sound menu or by pressing the “↔” button on your remote control, Pseudo/Spatial effect can be turned on or off. In Mono transmission the left and right channels will be added at left channel and dummy stereo effect will be introduced to end-user.

In stereo transmission it yields a phase difference between left and right channels. Hyper Sound selection will be displayed on the screen when the TV Status button is pressed or programme is changed.



Picture Mode

Picture mode OSD is displayed when BLUE button is pressed. Picture mode can be changed to standard, soft, and bright.

Sleep Timer

Sleep Timer mode OSD is displayed when YELLOW button is pressed.

The Sleep Timer is used to turn the TV off after a defined period of time after selecting this item. The timer can be programmed between Off and 120 minutes in steps of 10 minutes. (Off, 010, 020, 030, 040, ... , 120)

If sleep timer is activated, at the end of the selected time, the TV goes automatically to stand-by mode.

Mute Indicator

It is placed in the upper middle of the screen when enabled, and it stays there until it is disabled.



To cancel mute, there are two alternatives; the first one is by pressing the "X" button, this volume is set to the preceding value, and the second one is increasing or decreasing the volume level.

No-Signal Detection (TV mode)

If no valid signal detected, it takes 5 minutes to switch to the Stand-By mode unless any signal detected or any Remote Control command is accessed.

After a Remote Control command (if No-Signal Timer is active) the timer stops and if no signal detected again the timer is initialized to 5 minutes and starts 3 seconds later again to count down.

It is not valid in EXT modes.

No-Signal and Out Of Range Detection (PC mode)

In PC Mode, as no menu is displayed, in case that there is no PC input to the TV, it is displayed an OSD message:

No input signal detected

then the TV will turn to be in PC standby mode. In PC standby mode, the green lamp blinks.

Press "AV" button, digit buttons or "P∨" / "P∧" buttons to exit standby mode.

In PC Mode, if the resolution and the vertical frequency is not supported by the concept, it is displayed an OSD message:

Signal out of range

Volume Bar

It is displayed in the lower middle of the screen. When a volume command is received (pressing "▲ +" or "▲ -" by Remote Control or Control panel on the right side of the TV) and no menu is active, it stays on the screen for 3 seconds, after the last volume command or until another command is received in between.



EXT Modes

By pressing the "AV" button you can switch your TV to EXT modes (except being in Teletext). Pressing this button consecutively will switch the TV in one of the optional EXT modes: EXT-1, EXT-2, EXT-2 S, EXT-3, EXT-4, EXT-4 S and PC.

In order to quit the EXT mode press any digit buttons or "P∨" or "P∧".

Zoom Modes

Zoom mode can be changed by pressing the Red button. You can change the screen size according to the picture aspect ratio. Select the optimum one from the following **ZOOM** modes.

AUTO:

When a **WSS (Wide Screen Signalling)** signal, which shows the aspect ratio of the picture, is included in the broadcast signal or the signal from an external device, the TV automatically changes the **ZOOM** mode to **16:9 ZOOM** mode, **PANORAMIC** or **FULL** mode according to the **WSS** signal.

- When the **AUTO** mode does not function correctly due to poor **WSS** signal quality or when you want to change the **ZOOM** mode, change to another **ZOOM** mode manually.

Using the different screen formats

Press the Red button to select the different modes: **AUTO**, **FULL**, **REGULAR**, **PANORAMIC**, **14:9 ZOOM**, **16:9 ZOOM**, **16:9 ZOOM SUBTITLE** modes.

You can change the position of the picture in Zoom modes, except Full and Regular modes, by pressing the “▲” or “▼” button.

Note: You can only choose **REGULAR** and **FULL** in **PC** mode.

FULL:

This uniformly stretches the left and right sides of a normal picture (4:3 aspect ratio) to fill the wide TV screen.

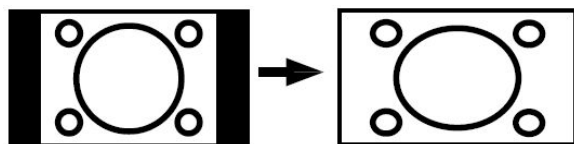

- For 16:9 aspect ratio pictures that have been squeezed into a normal picture (4:3 aspect ratio), use the **FULL** mode to restore the picture to its original shape.

REGULAR:

Use to view a normal picture (4:3 aspect ratio) as this is its original shape.

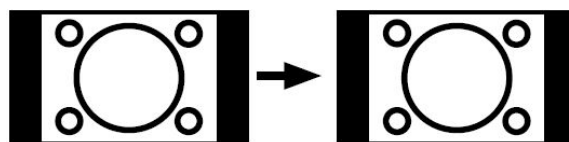

PANORAMIC:

This stretches the left and right sides of a normal picture (4:3 aspect ratio) to fill the screen, without making the picture appear unnatural.

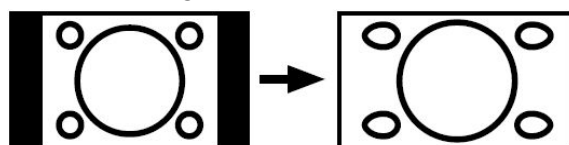

The top and bottom of the picture are slightly cut off.

14:9 ZOOM:

This zooms up the wide picture (14:9 aspect ratio) to the upper and lower limits of the screen.

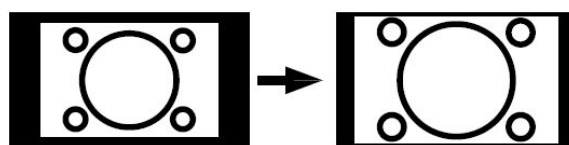

16:9 ZOOM:

This zooms up the wide picture (16:9 aspect ratio) to the full screen.

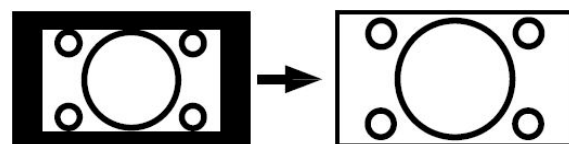

16:9 ZOOM SUBTITLE:

This zooms up the wide picture (16:9 aspect ratio) with subtitles to the full screen.

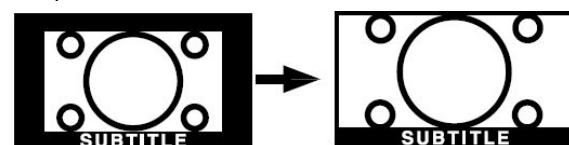

PC Mode

Installation

- Power off both Computer and Display before making any connections.
- Set your PC's resolution correctly before connecting to the TV. See the table in **page 29** for supported modes.
- Use a D-SUB cable to connect the TV's PC input to the computer's RGB output terminal. If you want to listen to the sound from the computer, use an audio cable to connect the PC AUDIO IN to the computer's sound output terminal.

15 Pin Mini D-Sub Connector

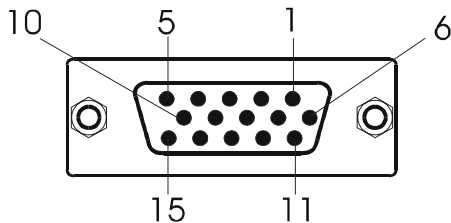

- Tighten the screws of the Display cable until the connectors are fastened securely (finger-tighten only).

Main Menu in PC mode

Enter the main menu by pressing the “MENU” button on the remote control.

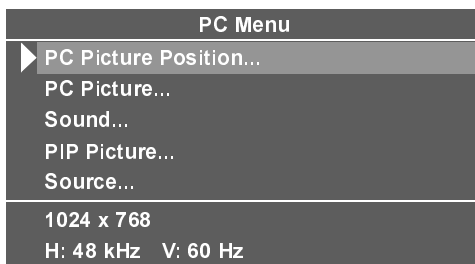

PC Picture Position Menu

In the Main menu, select “PC Picture Position” using “▲” or “▼” button, then enter the menu by pressing “◀” / “▶” or “OK” buttons.

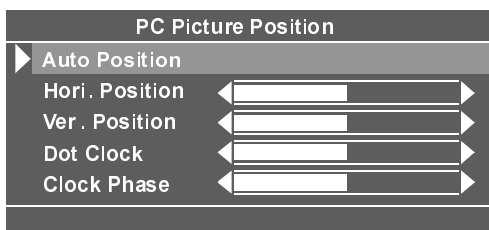

Auto Position

If you shift the picture horizontally or vertically to an unwanted position, use this item to put the picture into correct place automatically.

- Select Auto position item by using “▲” or “▼” buttons.
- Press “OK” button.
- Press “MENU” button or “BACK” button to store the value.

Warning: Auto position adjustment recommended to be done with the full screen image for the proper adjustment.

Horizontal Position

This item shifts the image horizontally to right hand side or left hand side of the screen.

- Select Hor. Position item by using “▲” or “▼” button.
- Use “◀” or “▶” button to adjust the value.
- Press “MENU” button or “BACK” button to store the value.

Vertical Position

This item shifts the image vertically towards the top or bottom of the screen.

- Select Ver. Position item by using “▲” or “▼” button.
- Use “◀” or “▶” button to adjust the value.
- Press “MENU” button or “BACK” button to store the value.

Dot Clock

Dot Clock adjustments correct interference that appear as vertical banding in dot intensive presentations like spreadsheets or paragraphs or text in smaller fonts.

- Use “◀” or “▶” button to adjust the value.

Clock Phase

Depending on the resolution and scan frequency that you input to the TV Set, you may see a muddy or noisy picture on the screen. In such a case you can use this item to get a clear picture by trial and error method.

- Use “◀” or “▶” button to adjust the value.

PC Picture Menu

In the Main menu, select “**PC Picture**” using “▲” or “▼” button, then enter the PC Picture menu by pressing “◀” / “▶” or “OK” buttons.

Contrast, Bright-1 and Colour Temperature adjustments in this menu are identical to adjustments defined in TV picture menu.

R, G and B adjust the TV image colour in PC mode. You can change the TV colour to your desired colour: R (Red), G (Green), B (Blue)

Press the BLUE button to reset the PC picture settings to default factory settings.

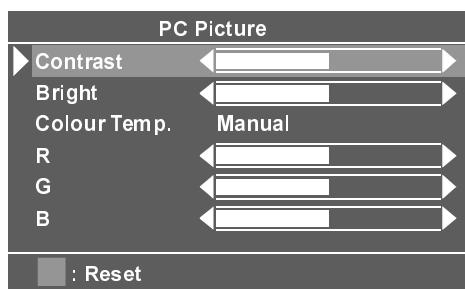

Sound Menu

In the main menu select “**Sound**” using “▲” or “▼” button, then enter the Sound menu by pressing “◀” / “▶” or “OK” buttons.

The items in this menu are described at Sound menu starting **page 16**.

PIP Picture

In the Main menu, select “**PIP Picture**” using “▲” or “▼” button, then enter the PIP Picture menu by pressing “◀” / “▶” or “OK” buttons.

This menu is displayed when PIP is displayed on the screen and otherwise “PIP No Signal” message will be displayed at the bottom of menu.

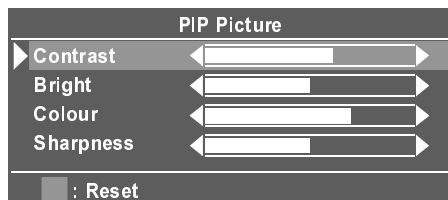

PIP picture is displayed on the screen with “◻” button. PIP position is changed by “Ⓛ” button. There are four different PIP positions.

PIP size is changed by “◻” button. Two different PIP sizes are available.

Programme in the PIP window is increased / decreased by “P∨ / P∧”, digit buttons or AV button. All EXT modes (except EXT-3) are also available in PIP window. PIP window is removed from the screen by “◻” button.

Press the BLUE button to reset the PIP picture settings to default factory settings.

The items in this menu are described at Picture menu starting page 14.

Source Menu

In the Main menu, select “**Source**” using “▲” or “▼” button, then enter the Source menu by pressing “◀” / “▶” or “OK” buttons.

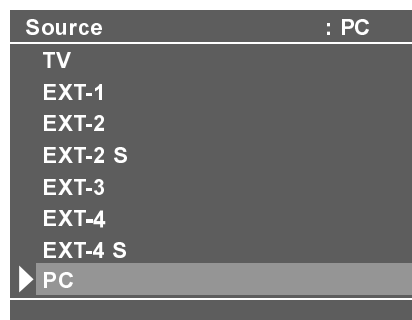

Select the available sources of TV, EXT-1, EXT-2, EXT-2 S, EXT-3, EXT-4, EXT-4 S or PC using “▲” or “▼” button and by pressing “◀” / “▶” or “OK” buttons.

Sound in PC mode

- Connect the PC’s Audio output to the TV’s **PC Audio In** socket with an audio cable.
- On your remote control, use “🎵” button to select sound source from TV, EXT-1, EXT-2, EXT-3, EXT-4 and PC options.
- When PIP is displayed on the screen, “🎵” allows you to switch sound between PC and selected PIP source.

Teletext

Teletext is an information system that displays text on your TV screen. Using the Teletext information system you can view a page of information on a subject that is available in the list of contents (index).

On screen display is not available in text mode. Contrast, brightness or colour control is not available, but volume control is available in text mode.

To operate Teletext

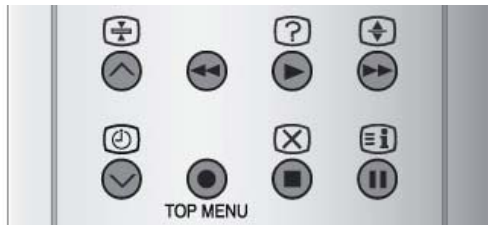

- Select a TV station on which Teletext is being transmitted.
- Press (TELETEXT) “” button. Usually the list of contents (index) is displayed on the screen.



To select a page of Teletext

- Press the appropriate digit buttons for the required Teletext page number.

The selected page number is displayed at the top left corner of the screen. The Teletext page counter searches until the selected page number is located, so that the desired page is displayed on the screen.

- Press “**P** ” button to move the Teletext screen forward one page at a time.
- Press “**P** ” button to move the Teletext screen backward one page at a time.

To Select Index Page



- To select the page number of the index (generally page 100), press “” button.

Searching for a teletext page while watching TV



- In the Teletext mode pressing “” button will switch the screen to the TV mode. In the TV mode enter a page number using digit

buttons. The page will be searched and the page number will be displayed on the upper left corner of the screen when the selected page is found. Now you can display this teletext page by pressing “” button.

To Select Double Height Text



- Press “” button for the top half of the information page to be displayed in double height text.
- Press “” button again for the bottom half of the information page to be displayed in double height text.
- Press “” button once more for the full page of normal height text.

To Reveal “concealed” Information

- Pressing “” button once will reveal answers on a quiz or games page.
- Pressing “” button again will conceal the revealed answers.



To Stop Automatic Page Change

The teletext page you have selected may contain more information than what is on the screen; the rest of the information will be displayed after a period of time.

- Press “” button to stop the automatic page change.
- Press “” button again to allow the next page to be displayed.

To Select a Subcode Page

Subcode pages are subsections of long Teletext pages that can only be displayed on the screen one section at a time.

- Select the required Teletext page.
- Press “” button.
- Select the required subcode page number by pressing four digit buttons (e.g. 0001).
- If the selected subcode page is not displayed in a short time, press “” button. TV programme will be displayed on the screen.
- Teletext page number will be displayed on the upper left corner of the screen when the

selected page is found.

- Press “**X**” button to display the selected Teletext page.

To exit Teletext

- Press “**≡**” button. The screen will switch to TV mode.

Fastext and Toptext

Your TV supports the 7 page Teletext system. When the page number of any of the 7 pages in memory is entered, the system will not search for the requested page; instead it will display the page automatically.

- Press “**P**^” button to move the Teletext screen forward one page at a time.
- Press “**P**∨” button to move the Teletext screen backward one page at a time.

For Fastext and Toptext

The subject-heading for the information may have a particular colour.

- Press an appropriate **RED, GREEN, YELLOW** or **BLUE** button in order to reach the relevant page quickly.

For TOPTTEXT

If Toptext transmission is present, colour coded buttons will appear in status row.

If Toptext transmission is not present, status row will not appear.

In Toptext mode the “**P**^” or “**P**∨” commands will request the next or previous page respectively. If Toptext transmission is not available, in case of operation of these commands, wraparound occurs. For example page 100 appears to be one greater than page 199.

Peripheral Equipment Connections

There is a wide range of audio and video equipment that can be connected to your TV.

Connection diagrams at the end of this section show you where the different equipment should be connected at the back side of the TV.

Via the Euroconnector

Your TV set has 2 Euroconnector sockets. If you want to connect peripherals (e.g. video, decoder, etc.) which have Euroconnectors, to your TV, use **SCART** input.

If an external device is connected via the Euroconnector socket, the TV is switched to AV mode automatically. In this case if both sockets are connected **SCART1** has the precedence.

T-V Link compatible VCR

Be sure to connect the T-V Link compatible VCR to the **EXT.2** terminal. If not, the T-V Link function will not work properly.

- When connecting a T-V Link compatible VCR to the **EXT.2** terminal, be sure to connect the decoder to the VCR. If not, the **T-V Link** function may not work properly. And then set the **DECODER(EXT-2)** function for the channel to **ON** to unscramble a scrambled channel.

RGB mode

If an equipment can output the **RGB** signals, connect it to the **EXT-1** or **EXT-2** terminal.

EXT-2 S Mode

If the equipment connected to your TV set supports S-Video (Y/C) output from Euroconnector, you can have a better picture quality by selecting **EXT-2 S** mode and connecting your equipment to the **EXT.2 (EXT-2 S)** terminal of TV. See your equipment's booklet to check if your equipment has such feature.

Via the RCA jacks

If you have an equipment (such as a Camcorder) which has the RCA jacks, connect it to the **EXT-4** terminal with the video and audio cables.

If you have a device which outputs component signal, connect it to the EXT-3 terminal with a component video cable.

Via the ANT (aerial) socket

If your equipment does not have an Euroconnector or RCA jacks, connect it to the TV with an aerial cable. For details, see the manual provided with the equipment.

- To store the test signal that comes from the equipment, see “Install Menu” on page 17 and store it to the program number 0. You can watch images from that equipment to select the program number which you stored the test signal.

Decoder

Cable TV offers you a wide choice of programmes. Most of them are free, others are to be paid for by the viewer. This means that you will need to subscribe to the broadcasting organisation whose programmes you wish to receive. This organisation will supply you a corresponding decoder unit to allow the programmes to be unscrambled.

For further information ask your dealer. See also the booklet supplied with your decoder.

Connect a decoder with an aerial socket to the TV

- Connect the aerial cable.

Connect a decoder without an aerial socket to the TV

- Connect the decoder to your TV with a eurocable (RCA Jack Cable) to **EXTERNAL** (RCA Jack) (optional). When your decoder has a Euroconnector / RCA Jack you can obtain better picture quality if you connect a eurocable (RCA Jack Cable) to **EXTERNAL** (RCA Jack) (optional).

TV and Video Recorder (VCR)

- Connect the Video Recorder to the ANT (antenna input) socket of the TV with the aerial cable.
- Connect the Video Recorder to the **EXT-1** or **EXT-2** terminal with the SCART cable, or connect it to the **EXT-4** terminal with the audio and video cables.

NTSC Playback

Connect a NTSC video recorder to a terminal. Then press “AV” button to select the corresponding AV mode.

NTSC 3.58/4.43 system is detected automatically in AV mode.

Camera and Camcorder

To connect to the EXT-4 terminal

Connect your camera or camcorder at the back side of your TV.

- Connect your equipment to the TV via **VIDEO** (yellow), **AUDIO R** (red) and **AUDIO L** (white) inputs. You should connect the jacks to the input in the same colour.

Connect the decoder to the video recorder

Some video recorders have a special euroconnector for decoder.

- Connect an eurocable to the euroconnector of your decoder and to the special euroconnector of your video recorder. See also the handbook of your video recorder.
- To connect your video recorder to the TV, see TV and Video Recorder section.

If you want to connect more equipment to your TV, consult your dealer.

Connecting Headphones

Use the stereo headphone socket on the right side of your TV, to connect headphones.

Connecting the PC

Connect PC monitor with 15-pin PC cable to the 15-pin connector on the rear of the computer. For detailed installation procedure see **Installation** in PC mode.

To connect to S-Video input

Connect your camera or camcorder at the back side of your TV.

- Connect your equipment to the TV via S-Video input at the back side by using S-Video cables.

Antenna Connections

Outdoor Antenna Connections

VHF antenna

Method 1

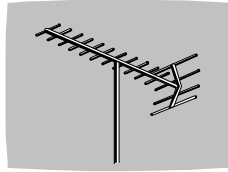

Round 75 ohm coaxial cable

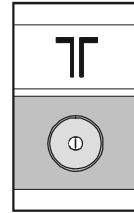

Rear of TV

VHF/UHF antenna

Method 2

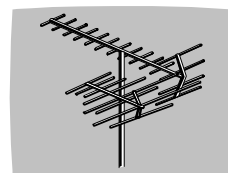

Flat 300-ohm twin lead cable

Round 75-ohm coaxial cable

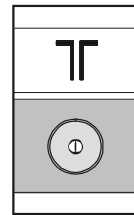

Rear of TV

Peripheral Equipment Connections

HEADPHONE

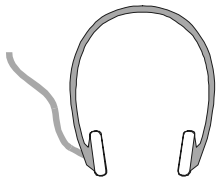

AUDIO

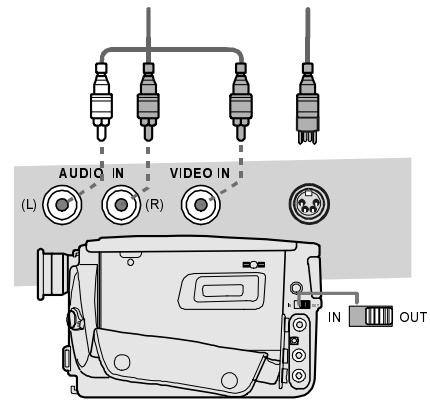
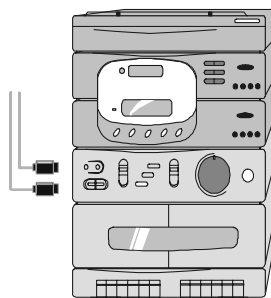

CAMCORDER

VIDEO

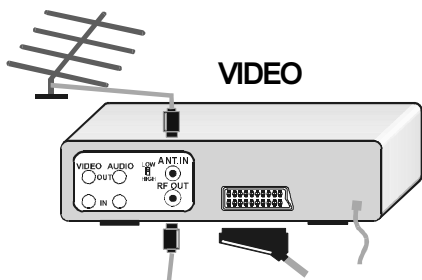

FOR SATELLITE RECEIVER

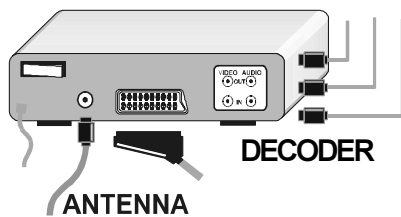

ANTENNA

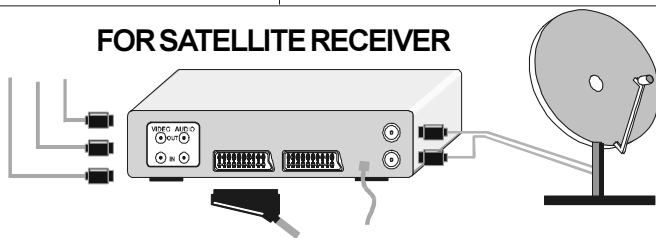

PC Input Typical Display Modes

The display has a maximum resolution of 1360 x 768, vertical sync. frequency range of 50-75 Hz and a horizontal sync. frequency range of 30-69 KHz.

The following table is an illustration of some of the typical video display modes.

<i>Mode</i>	<i>Resolution</i>		<i>Frequency</i>	
	<i>Horizontal</i>	<i>Vertical</i>	<i>Hor. (kHz)</i>	<i>Ver. (Hz)</i>
1	640	400	31.5	70
2	640	480	31.5	60
3	640	480	37.9	72
4	640	480	37.5	75
5	720	400	31.5	70
6	800	600	35.2	56
7	800	600	37.9	60
8	800	600	48.1	72
9	800	600	46.9	75
10	1024	768	48.4	60
11	1024	768	56.5	70
12	1024	768	60.0	75
13	1280	720	44.6	60
14	1280	768	47.6	60
15	1360	768	47.6	60

The native resolution of the TFT-LCD Panel is 1366 x 768. Therefore using Mode 15 is advised to get the best PC input display quality.

Tips

Can not turn the TV on?

Check that TV/VCR/DVD switch is set to TV position.

TV may go to standby mode when you turn the TV on soon after you turn the TV off. If you can turn the TV on again, it is not a problem.

Can not turn the TV off?

Check that TV/VCR/DVD switch is set to TV position.

Care of the Screen

Clean the screen with a slightly damp, soft cloth. Do not use abrasive solvents as they may damage the TV screen coating layer.

Colors of image on screen are abnormal

Have you selected the correct TV system? Is your TV set or house aerial located too close to the loudspeakers, non-earthed audio equipment or neon lights, etc. ?

Mountains or high buildings can cause double pictures or ghost images. Sometimes you can improve the picture quality by changing the direction of the aerial.

Is the picture or Teletext unrecognisable? Check if you have entered the correct frequency.

The picture quality may degrade when two peripherals are connected to the TV at the same time. In such a case, disconnect one of the peripherals.

No Image on Display Screen

Is the aerial connected properly? Are the plugs connected tightly to the aerial socket? Is the aerial cable damaged? Are suitable plugs used to connect the aerial? If you are in doubt, consult your dealer.

No Image means that your TV is not receiving any transmission. Have you pressed the correct buttons on the remote control? Try once more.

PC Picture

If no PC picture appears, check that the D-SUB cable is connected properly. Check that your PC's resolution set correctly. See **page 29** for supported modes.

Sound

You can not hear any sound. Did you perhaps interrupt the sound by pressing "~~X~~" button? Are external speakers connected to the TV?

Sound is coming from only one of the speakers. Is the balance set to one direction extreme? See **Sound** menu.

Remote Control

If your TV no longer responds to the remote control, perhaps the batteries are exhausted. Replace the batteries.

Have you selected the wrong menu? Press "**MENU**" button to return to normal screen or press "**BACK**" button to return to the previous menu.

No solution

Switch your TV set off and on. If this does not work, switch off, remove the mains plug and call the service personnel; never attempt to repair it yourself.

Specifications

Item	Model	LT-26B60BU	LT-26B60SU
Broadcasting Systems		PAL SECAM BG, DK, I, L, Lp	
Channels and Frequencies		VHF (VL) 46,25 MHz - 168,25 MHz VHF (VH) 175,25 MHz - 463,25 MHz UHF 471,25 MHz - 863,25 MHz Cable TV (S1-S20/S21-S41)	
Input Signal		Video: Analog 0,7 Vp-p 75 ohm positive Sync: TTL Level positive or negative, Seperate sync.	
Horizontal Timing		30 - 69 KHz	
Vertical Timing		50 - 75 KHz	
Dot Rate		78.75 MHz max.	
Panel Size		26" (600 mm) (measured diagonally)	
Visible Picture Size		566 mm horizontal x 340 mm vertical	
Display Resolution		1366 x 768 max. (WXGA)	
Number of Preset Channels		100	
Channel Indicator		On Screen Display (OSD)	
RF Aerial Output		75 Ohm (unbalanced)	
Power Requirements		220-240 V AC, 50 Hz	
Power Consumption (W)		140 W (max) / STANDBY <3W	
Sound Systems		German, Nicam Stereo	
Audio Output		2 x 8 W _{RMS} (%10 THD)	
EXT-1 Terminal		Euroconnector (21-pin, SCART 1) (back of the cabinet) • Video Input, Audio L/R Inputs and RGB inputs are available. • TV broadcast outputs (Video and Audio L/R) are available.	
EXT-2 Terminal		Euroconnector (21-pin, SCART 2) (back of the cabinet) • Video Input, S-VIDEO (Y/C) input, Audio L/R and RGB inputs are available. • Video and Audio L/R outputs are available. • T-V Link functions are available.	
EXT-3 Terminal		RCA connectors x 5 (back of the cabinet) • Component video (Pr, Pb, Y) inputs and Audio L/R inputs are available.	
EXT-4 Terminal		RCA connectors x 3 (side of the cabinet) S-VIDEO connector x 1 (side of the cabinet) • Video input, S-VIDEO (Y/C) input and Audio L/R inputs are available.	
AUDIO OUT Terminal		RCA connectors x 3 • Audio L/R outputs are available. • Subwoofer out is available.	
PC IN terminal		Analog RGB D-SUB 15 x 1 • PC signal is available (refer to page 29 for details of the signals which can be input)	
PC AUDIO IN terminal		Stereo mini-jack (3.5 mm diameter)	
Dimensions (W x H x D)		703 mm x 578 mm x 223 mm 703 mm x 523 mm x 98 mm (TV only)	
Weight		13 kg (with stand) / 11.4 kg (TV only)	
Accessories		Remote control unit x 1 (RM-C1860) / AA/R6 dry cell battery x 2 Power cord x 1	
Headphone jack		Stereo mini-jack (3.5 mm diameter)	